

LiFePO4 Battery System for Households



USER GUIDE

LiFePO4 Battery System for Households



In order to prevent improper operation before use, please carefully read this manual.

Contents

1 ABOUT THIS MANUAL	1
1.1 Purpose	1
1.2 Scope	1
1.3 Safety Instructions	1
1.4 Can be Connected in Parallel	1
2 INTRODUCTION	2
2.1 Features.....	2
2.2 Product Overview	2
2.3 Specifications	4
2.4 Recommended Settings	5
3. INSTALLATION	6
3.1 Unpacking and Inspection	6
3.2 Tools	8
3.3 Floor Installation with Base	8
3.4 Installation Environment	9
3.5 Product size information	10
4. INSTALLATION	10
4.1 Unpacking and Inspection	10
4.2 Mounting the Unit	11
4.3 Connection for Parallel Mode	12
5. OPERATION	14
5.1 Switch On / Off	14
5.2 Description for LED	14
5.3 ON / OFF or SOC Led (Mode or SOC)	15
6. LCD Display Icons	15
6.1 BMS Information Page	16
6.2 Fault Code Table	17
6.3 DIPswitch SW1-SW4 Description	18
7. EMERGENCY SITUATIONS	19
7.1 Fire	19
7.2 Leaking Batteries	19
7.3 Wet Batteries	19
7.4 Damaged Batteries	19
7.5 Warranty	19

1 ABOUT THIS MANUAL

1.1 Purpose

This manual describes the introduction, installation, operation and emergency situations of the battery bank. Please read this manual carefully before installations and operations. Keep this manual for future reference.

1.2 Scope

This manual provides safety and installation guidelines as well as information on tools and wiring.

1.3 Safety Instructions



WARNING: This chapter contains important safety and operating instructions. Read and keep this manual for future reference.

1. Before using the unit, read all instructions and cautionary markings on the unit, the batteries and all appropriate sections of this manual.
2. CAUTION --- To reduce risk of injury, damage, even burst, please use it following using manual. In case of causing personal
3. Do not disassemble the battery. Take it to a qualified service center when service or repair is required. Incorrect re-assembly may result in a risk of fire.
4. To reduce risk of electric shock, disconnect all wirings before attempting any maintenance or cleaning. Turning off the unit will not reduce this risk.
5. CAUTION – Only qualified personnel can install this device with inverter.
6. For optimum operation of this battery, please follow required spec to select appropriate cable size.
7. Be very cautious when working with metal tools on or around batteries. A potential risk exists to drop a tool to spark or short circuit batteries or other electrical parts and could cause an explosion or fire.
8. Please strictly follow installation procedure.
9. **GROUNDING INSTRUCTIONS** - This System should be connected to a permanent grounded wiring system. Be sure to comply with local requirements.
10. NEVER cause AC output and DC input short circuited. Do not connect to the mains when DC input short circuits.
11. Warning!! Only qualified service persons are able to service this device.
12. Battery should be installed indoor and kept away from water, high temperature mechanical force and flames.
13. Do not install the battery in any environment of temperature below 0°C or over 55°C, and humidity over 80%.
14. Do not put any heavy objects on the battery.

1.4 Can be Connected in Parallel

1. The batteries can be connected in parallel. Series connection is not allowed. Use in upright position only.
2. The batteries are not allowed to connected with PWM controller for charging.

Special Attention: Due to the built-in protection board of the lithium battery pack is with over-discharge protection function, it is strongly recommended to stop using the load when the battery pack is over-discharged. The battery pack cannot be repeatedly activated for discharge. Or the battery may be failed to be activated by the AC or PV activation cable (It requires a special charging activation method), so cannot be charged. Therefore, when the battery pack is low power, please charge the battery as soon as possible when main power or solar energy is available.

2. INTRODUCTION

The battery system main using solar power system for family house. It also have a with to controller the battery easily and protect our Household application timely.

2.1 Features

Features:

- LiFePO4: Higher safe performance and longer cycle life.
- Multiple Protection: Built-in smart BMS, Breaker and Fuse.
- Modular design for easy installation and increased capacity
- Flexible Installation: Wall-Mounted or Floor-Mounted.
- Wide Compatibility: Compatible with leading inverter brands.
- High Scalability: Capacity up to 40.96kWh.

2.2 Product Overview

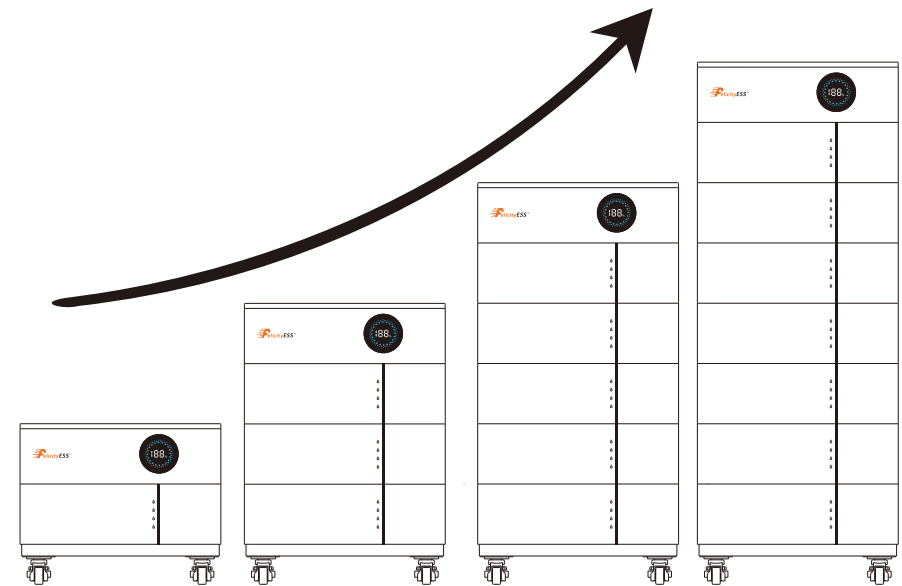

Up to 8 PCS battery packs can be connected in parallel

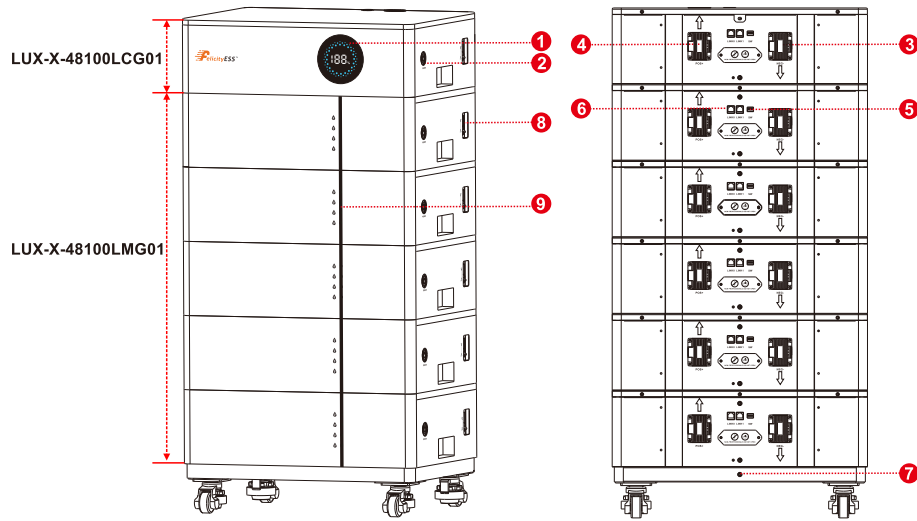

- 1. LCD display
- 2. Power On/Charging indicator
- 3. Battery Negative -
- 4. Battery Positive +
- 5. Switch
- 6. Communication port
- 7. Earth wire
- 8. Breaker
- 9. LED

LUX-X-48100LCG01 and LUX-X-48100LMG01 both of battery packs contain batteries inside

✳ 9. Fuse(Non professionals are not allowed to open this cover)

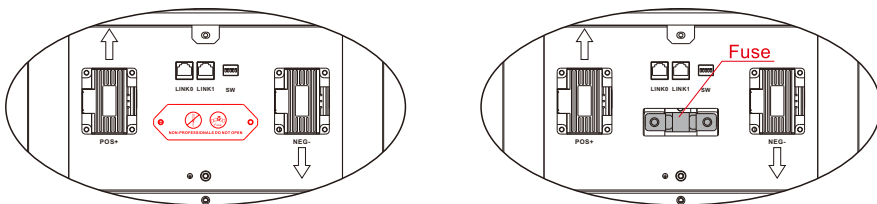

If the fuse is burnt out, please open the cover and replace it

2.3 Specifications

Model	LUX-X-48100LG01							
Battery Type	LiFePO4							
Module Nominal Energy	5.12kWh							
Module Nominal Capacity	100Ah							
Module Nominal Voltage	51.2V							
Number of Battery Modules	1	2	3	4	5	6	7	8
System Nominal Energy	5.12kWh	10.24kWh	15.36kWh	20.48kWh	25.6kWh	30.72kWh	35.84kWh	40.96kWh
System Nominal Voltage	51.2V							
System Operating Voltage	44.8~57.6V							
Recommend Charge/Discharge Current	50A	100A	150A	200A	250A	300A	350A	400A
Max.continuous charge/Discharge current[1]	60A	120A	180A	240A	300A	360A	400A	400A
Peak Charge/Discharge Current(15s)	100A	200A	300A	400A	500A	600A	700A	800A
Scalability	Max.8 pcs in Parallel(40.96kWh)							
Depth of Discharge(DOD)	≥ 95%							
Display type	Control Module:LCD/Battery Module:LED*4							
Protection Level	IP21							
Working Temperature Range	Charge: 0°C~+55°C							
	Discharge:-20°C~+55 °C							
Storage Temperature Range	0°C~+35°C							
Humidity	5%~95%							
Altitude	≤ 2000m							
Communication	RS485 / CAN							
Cycle Life[2]	≥ 6000 Cycles							
Installation	Wall-Mounted / Floor-Mounted							
Protection	Built-in smart BMS, Breaker, Fuse							
Warranty Period[3]	10 Years							
Control Module LUX-X-48100LCG01	Product Weight Approximate	46kg						
	Package Weight Approximate (with base)	60kg						
	Product Dimension	600x450x180mm						
	Package Dimension(with base)	712x562x333mm						
Battery Module LUX-X-48100LMG01	Product Weight Approximate	46kg						
	Package Weight Approximate	50kg						
	Package Dimension	712x562x298mm						

[1] Max.continuous charge/Discharge current is affected by temperature and SOC.

[2] Test conditions: 0.2C Charging/Discharging @25°C, 80% DOD.

[3] Conditions apply, refer to FelicityESS Warranty policy.

2.4 Recommended Settings

Lithium battery pack is not same as lead-acid battery, so for the devices which you connect with the battery pack for charging or discharging, such as inverters, MPPT charger controllers or UPS, please implement pre-settings as recommended settings as below before you launched them.

Setting	LUX-X-48100LG01
Max. Charging Voltage	57.6V
Floating charging Voltage	57.6V
Max. Charging Current	60A*N(Max=400A)
Cut-off voltage	48V

Notes:"N"means the number of battery packs connected parallel and should not exceed 8.(N≤8)

3. Installation Procedure

3.1 Setup Script

Step 1: Open the packaging Carton box and remove the accessories(LUX-X-48100LCG01 battery pack, base, wheel*4PCS) ;

Step 2:Open the packaging Carton box and remove the accessories (LUX-X-48100LMG01 battery pack) .

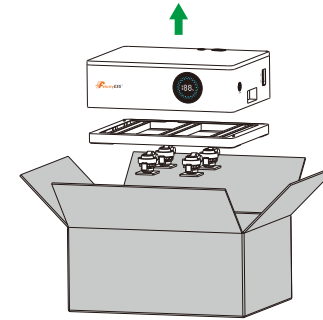

LUX-X-48100LCG01

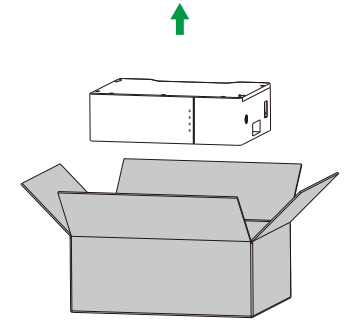

LUX-X-48100LMG01

Step 3: Fix the 4 casters on the base using M6X16 screws

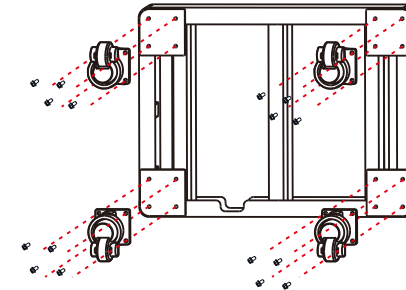

Step 4: Place the base, which should be 35MM away from the wall.

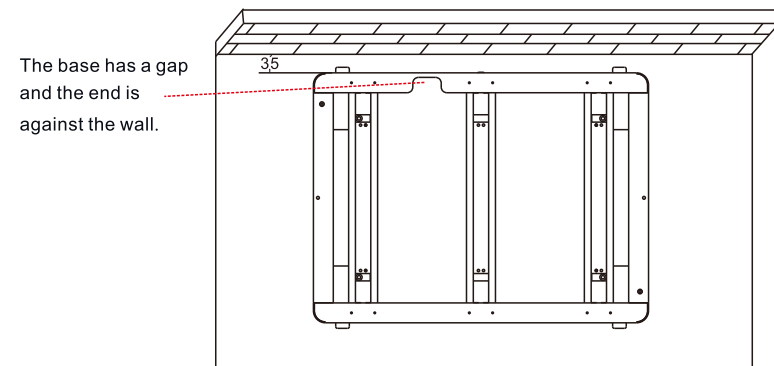

Step 5: Use wall mounted positioning cardboard, and mark the holes layer by layer.

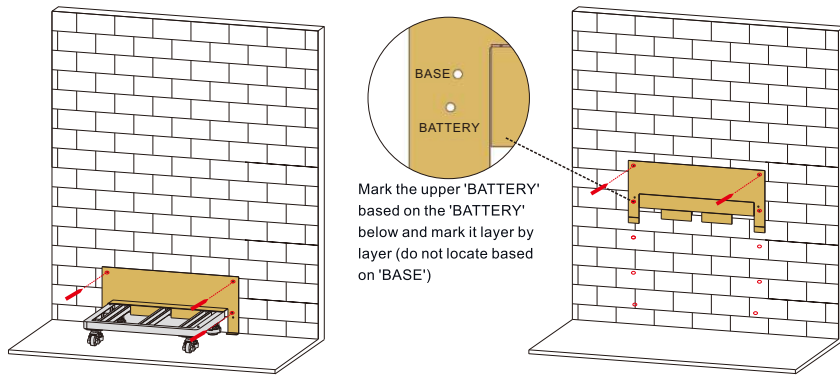

Mark the upper 'BATTERY' based on the 'BATTERY' below and mark it layer by layer (do not locate based on 'BASE')

Step 6: Drill holes according to the position marked on the installation hole position cardboard (note: the hole diameter is 10mm, and the drilling depth is 60mm)

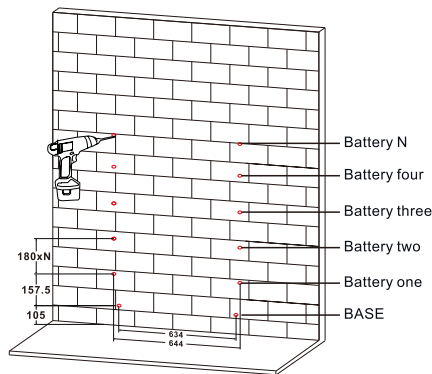

Step 7: Stack and place the products, with a base on the bottom layer, LED lights on the middle layer, and an LCD display screen on the top layer

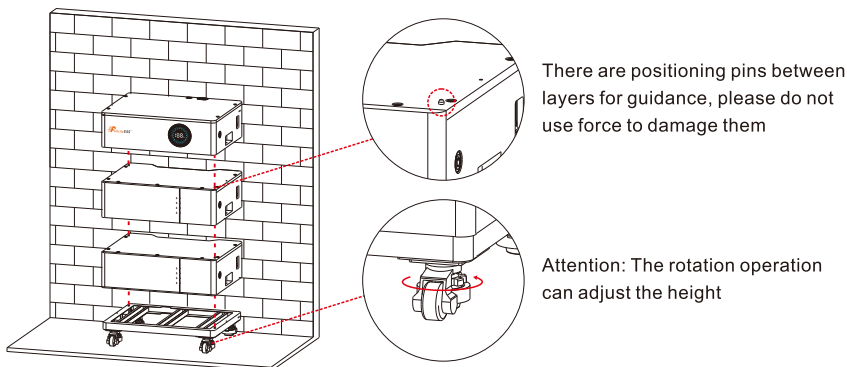

There are positioning pins between layers for guidance, please do not use force to damage them

Attention: The rotation operation can adjust the height

Step 8: Use sheet metal lock wall components to fix the product on the wall

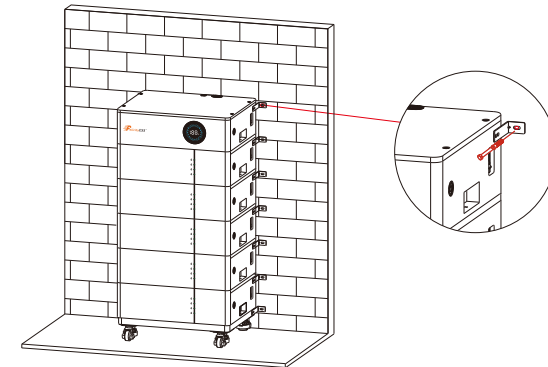

The battery packaging layer is fixed between the layers using hexagonal screws (at the handle)

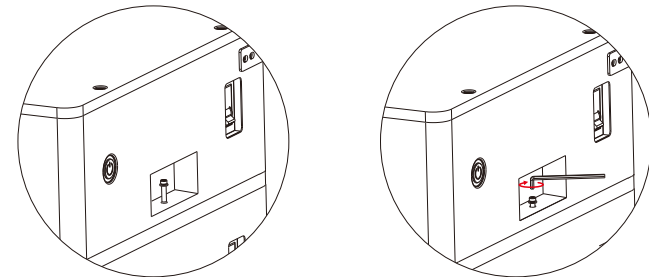

3.2 Tools



Screw Driver



Crimping Modular



Safety Shoes



Multimeter



Safety Gloves



Safety Goggles



Plier



Ribbon



Electric drill

3.3 Floor Installation with Base Installation Location Requirements

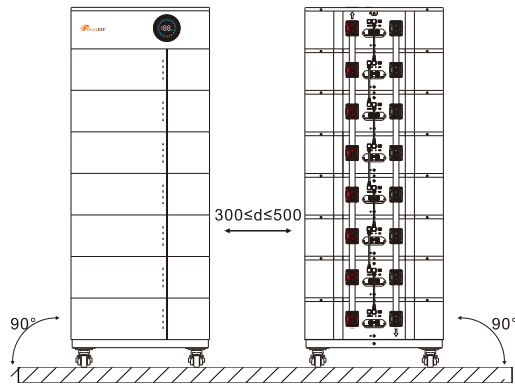

Ground (Two rows installation)

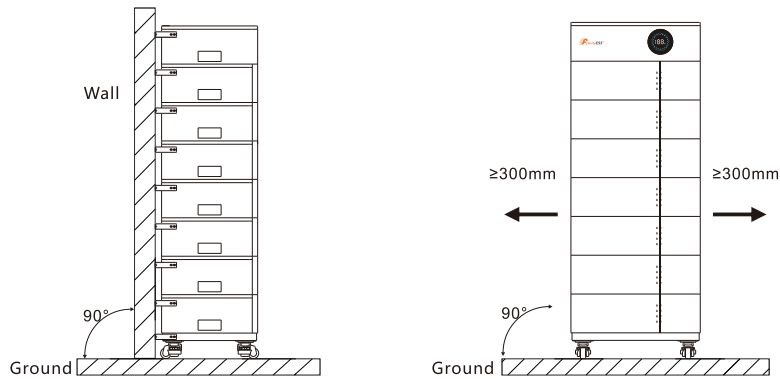

3.4 Installation Environment

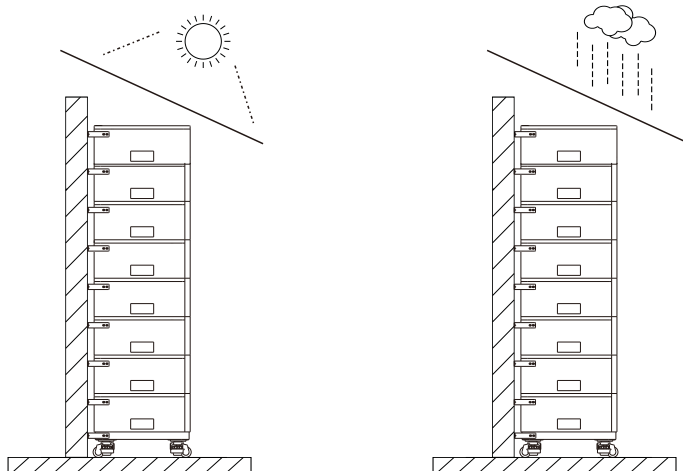

Max. +55°C



Min. -20°C



RH. +5%~+95%



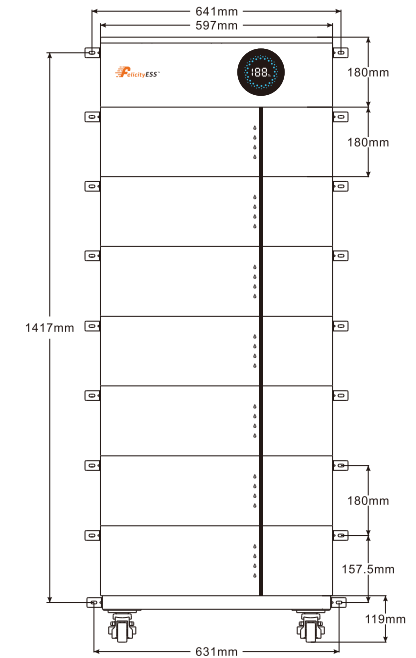
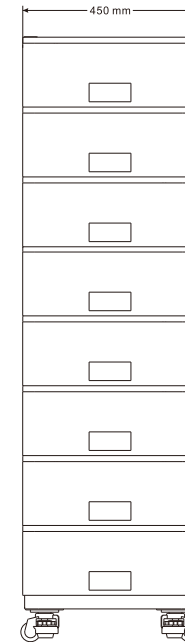

3.5 Product size information





















4. INSTALLATION

4.1 Unpacking and Inspection

Before installation, please inspect the unit. Be sure that nothing inside the package is damaged. You should have received the following items inside of package.

LUX-X-48100LCG01			
 CAN com line x1 RS485 com line x1	 Communication line x1	 Cables x2	 Castor x4

 User manual x1	 Warranty card x1	 Universal wrench x1	 CAN/485 com line x1
 Base x1	 Lock wall components x2	 Grounding wire x1	 Plastic expansion nail x4
 Hole marking cardboard x1	 Wiring baffle x1		

LUX-X-48100LMG01			
 Lock wall components x2	 Series communication line x1	 Series connection soft copper busbar x2	 User manual x1
 Lock wall components x1	 Warranty card x1	 Plastic expansion nail x2	 Wiring baffle x1

4.2 Mounting the Unit

Consider the following points before selecting where to install:

- Do not mount the battery on flammable construction materials.
- The ambient temperature should be between 0°C and 45°C to ensure optimal operation.
- The recommended installation position is to be adhered to the wall vertically.
- Be sure to keep other objects and surfaces as shown in the right diagram to guarantee sufficient heat dissipation and to have enough space for removing wires.

Please follow below steps to implement battery connection:

1. Assemble battery ring terminal based on recommended battery cable and terminal size.
2. Connect all battery packs as units requires. It's suggested to connect at least 2 sets for inverter larger than the energy of a battery pack in parallel connection.

4.3 Connection for Parallel Mode

Please open the lid latch upwards, rotate the lid and tear off the lid cover. Use screws to connect the copper bar, with the positive pole connected from bottom to top and the negative pole connected from top to bottom.

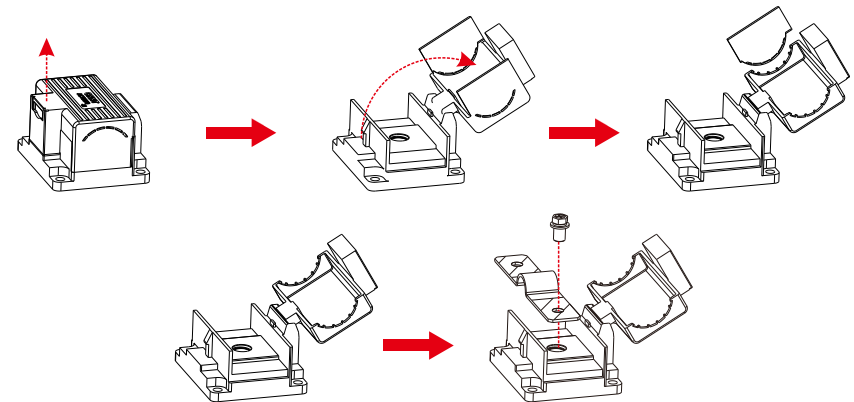

The LUX-X-48100LG01 series battery support to be connected in parallel for expansion. If you need one more battery bank work in parallel mode, connect the battery as shown in PIC 1.

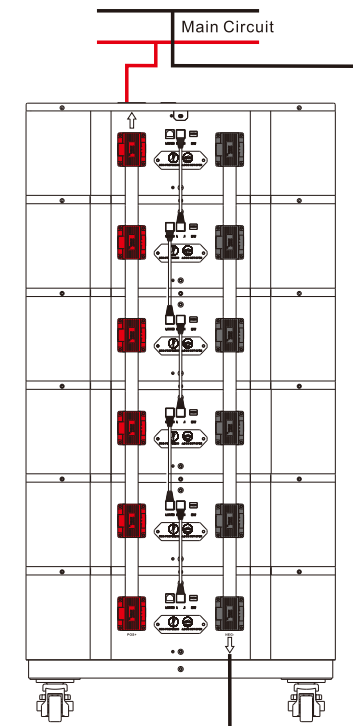

The diagram of six battery strings in parallel is shown in the figure above. In order to maintain the current balance of the battery pack, please ensure that the negative electrode of the battery comes out from the bottom.

Adjust each battery pack dialer from left to right according to the diagram below (from top to bottom)

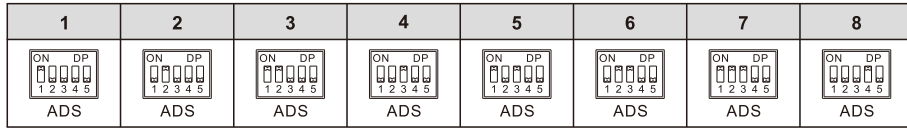

Note: After completing the above steps, arbitrarily select the positive and negative poles of one of the battery packs to output. After confirming the correct connection of the inverter, controller and battery, you can turn on any of the switches and use the battery group happily.

For pure off-grid systems, the power line needs to be connected to the battery's MPPT charging controller and the battery pack is only charged by the solar panel, the connection diagram is as follows:

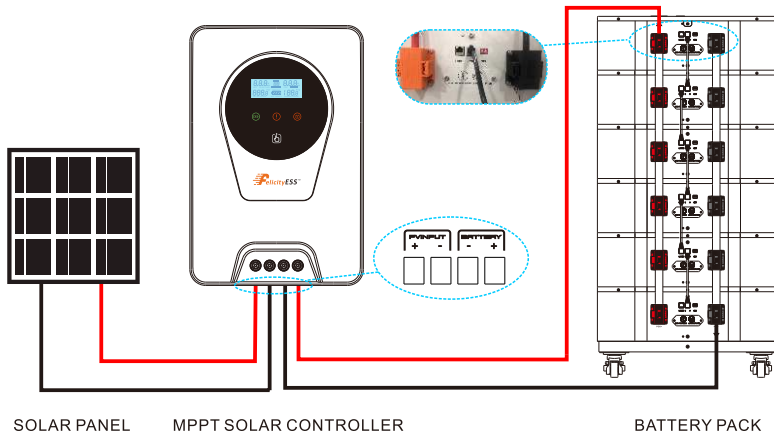

5. OPERATION

Once the batteries are connected well, close the breaker to the ON block, press On/Off button to enable the output of the battery pack.

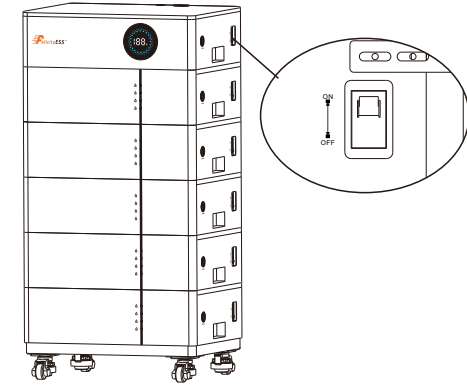

5.1 Switch On / Off

1. Switch on: press On/Off button to switch on the battery, then the battery will do self-inspection before enable output. The LCD will show the SOC.
2. Switch off: press and hold On/Off button for 1 to 3 seconds, the battery will shut down directly.

Picture	PIN	Description
	1	Trigger-GND
	2	Trigger-VCC
	3	CANL-PCS
	4	CANH-PCS
	5	RS485-B
	6	RS485-A
	7	CANL
	8	CANH

DIP SWITCH		
	1-4	Communication Address
	5	Termination Resister

5.2 Description for LED

The LED shows the SOC of module N.

100%	75%	50%	25%	Flashing SOC < 10%

Note: The battery need to be fully charged for at least once in one month to ensure the accurate SOC calculation.

5.3 ON / OFF or SOC Led (Mode or SOC)

BATTERY MODE	ON/OFF		SOC				REMARK
	GREEN LED	RED LED	LED1	LED2	LED3	LED4	
POWER OFF	OFF	OFF	OFF	OFF	OFF	OFF	
POWER ON	OFF	ON	ON	ON	ON	ON	
STANDBY	OFF	OFF	SOC				SOC <10%(DEFAULT): LED1 FLASH
NORMAL	ON	OFF	RUNNING /SOC				SOC <10%(DEFAULT): LED1 FLASH
DISCHARGE	ON	OFF	SOC				SOC <10%(DEFAULT): LED1 FLASH
CHARGE	FLASH	OFF	RUNNING				
LOW POWER	FLASH	OFF	OFF				
FAULT	OFF	ON	ON	OFF	OFF	OFF	BATTERY VOLTAGE HIGH
			OFF	ON	OFF	OFF	BATTERY VOLTAGE LOW
			ON	ON	OFF	OFF	CELL VOLTAGE HIGH
			OFF	OFF	ON	OFF	CELL VOLTAGE LOW
			ON	OFF	ON	OFF	CHARGING CURRENT HIGH
			OFF	ON	ON	OFF	DISCHARGING CURRENT HIGH
			ON	ON	ON	OFF	BMS TEMPERATURE HIGH
			OFF	OFF	OFF	ON	BMS TEMPERATURE LOW
			ON	OFF	OFF	ON	CELL TEMPERATURE HIGH
			OFF	ON	OFF	ON	CELL TEMPERATURE LOW
ON	ON	OFF	ON	CURRENT SENSOR ABNORMAL			

6. LCD Display Icons



Icon	Function Description
Display Information	
	Indicates the voltage, current, temperature, SOC of the module. (Short press the button to display the information of each parallel module.)
	Indicates SOC
	Indicates battery level, each LED represents 5%. (When charging, this icon flashes; when discharging, the icon displays constant)
	Indicates settings.
	Indicates a fault.
	Indicates communication signs.

6.1 BMS Information Page

The basic information will be displayed in turn after power on.

<p>BMS power on information BMS information is all on.</p>	<p>BMS version Eg: "516" is the software version, "500" is the IAP version and temporary version.</p>
<p>BMS type Eg: Rated voltage is "48V", model is "100AH".</p>	<p>BMS data This interface indicates that it is in SOC calibration.</p>
<p>BMS data Eg: "70%" refer to battery SOC, "C" indicates that the battery is charging, and if it is discharging, "d" is displayed. "2" indicates that the data currently displayed is for module 2, "65%" represents the SOC of module 2. Short press the button to display the information of each parallel module</p>	<p>BMS data Eg: "70%" refer to battery SOC, "52.0V" refer to battery voltage, "35A" refer to battery current. Short press the button to display the information of each parallel module</p>
<p>BMS fault code / flag Eg: "52.0V" / "C09" / "70%" are battery voltage, fault code and SOC respectively, and Fault icon constant</p>	

6.2 Fault Code Table

Fault Code	Fault information	Trouble Shooting
C01	Battery overvoltage	Restart the unit, if the error happens again, please return to repair center.
C02	Battery undervoltage	Restart the unit, if the error happens again, please return to repair center.
C03	Cell overvoltage	Restart the unit, if the error happens again, please return to repair center.
C04	Cell undervoltage	Restart the unit, if the error happens again, please return to repair center.
C05	Charge overcurrent	Restart the unit, if the error happens again, please return to repair center.
C06	Discharge overcurrent	Restart the unit, if the error happens again, please return to repair center.
C07	MOS overtemperature	1. The inner temperature is over the limitation. 2. Check whether the ambient temperature is too high.
C07	MOS overtemperature	1. The inner temperature is over the limitation. 2. Check whether the ambient temperature is too high.
C08	MOS undertemperature	1. The internal temperature is lower than the limit range. 2. Check whether the ambient temperature is too low.
C09	Cell overtemperature	Restart the unit, if the error happens again, please return to repair center.
C10	Cell undertemperature	Restart the unit, if the error happens again, please return to repair center.
C11	Abnormal current sampling	Restart the unit, if the error happens again, please return to repair center.
C12	Abnormal output impedance	Restart the unit, if the error happens again, please return to repair center.
C13	Parallel failed	1. Please check if single unit is installed to parallel system. 2. If this error happens during parallel installation, please check wires connection. If they are connected correctly, please finish parallel installation first, and then Restart the unit. 3. If the problem remains, please contact your installer.
C14	Output loss	1. Please check whether the circuit breaker is closed; 2. Please check whether the fuse is normal; 3. Restart the unit, If the error happens again, please return to repair center.

6.3 DIP switch SW1-SW4 Description

DIP switch SW1-SW4 Description ①						DIP switch SW5 Description②			
SW1	SW2	SW3	SW4	Remarks	SW5	Remarks			
0	0	0	0	means ID=0,communication address is0x00/0x10③	1	means connect 120Ω resistor			
1	0	0	0	means ID=1,communication address is0x01④					
0	1	0	0	means ID=2,communication address is0x02	0	means disconnect 120Ω resistor			
1	1	0	0	means ID=3,communication address is0x03					
0	0	1	0	means ID=4,communication address is0x04					
1	0	1	0	means ID=5,communication address is0x05					
0	1	1	0	means ID=6,communication address is0x06					
1	1	1	0	means ID=7,communication address is0x07					
0	0	0	1	means ID=8,communication address is0x08					
1	0	0	1	means ID=9,communication address is0x09					
0	1	0	1	means ID=10,communication address is0x0A					
1	1	0	1	means ID=11,communication address is0x0B					
0	0	1	1	means ID=12,communication address is0x0C					
1	0	1	1	means ID=13,communication address is0x0D					
0	1	1	1	means ID=14,communication address is0x0E					
1	1	1	1	means ID=15,communication address is0x0F					
Remark①: 1 in SW1-SW5 indicates ON status, and 0 indicates OFF status.									
Remark②: When multiple battery packs communicate, the last battery pack SW5 needs to be in the ON status, otherwise the communication may have interference.									
Remark③: When the battery pack ID is set to 0, it means stand-alone operation, and it is not necessary to detect whether the parallel condition is satisfied ⑤									
Remark④: When the battery pack ID is set to 1-15, it means that the parallel operation is required, and it is necessary to detect whether the parallel condition is satisfied ⑤									
Remark⑤: The parallel condition is that the difference between the battery voltage of the local battery and all the battery pack voltages is <3V, otherwise wait until the condition is satisfied									

7. EMERGENCY SITUATIONS

FelicityESS cannot guarantee battery absolute safety.

7.1 Fire

In case of fires, make sure that the following equipment is available near the system.

- SCBA (self-contained breathing apparatus) and protective gear in compliance with the Directive on Personal Protective Equipment 89/686/EEC.
- NOVEC 1230, FM-200, or dioxide extinguisher

Batteries may explode when heated above 150°C. KEEP FAR AWAY from the battery if it catches fire.

7.2 Leaking Batteries

If the battery pack leaks electrolyte, avoid contact with the leaking liquid or gas. If one is exposed the leaked substance, immediately perform the actions described below.

- Inhalation: Evacuate the contaminated area, and seek medical attention.
- Contact with eyes: Rinse eyes with running water for 5 minutes, and seek medical attention.
- Contact with skin: Wash the affected area thoroughly with soap and water, and seek medical attention.
- Ingestion: Induce vomiting, and seek medical attention.

7.3 Wet Batteries

If the battery pack is wet or submerged in water, do not let people access it, and contact your supplier for help.

7.4 Damaged Batteries

Damaged batteries are not fit for use and are dangerous and must be handled with the utmost care. It may leak electrolyte or produce flammable gas. If the battery pack seems to be damaged, pack it in its original container, and then return it to your supplier.

7.5 Warranty

Products that are operated strictly in accordance with the user manual are covered by the warranty. Any violation of this manual may void the warranty.

Limitation of Liability

Any product damage or property loss caused by the following conditions, FelicityESS does not assume any direct or indirect liability.

- Product modified, design changed or parts replaced.
- Changed, or attempted repairs and erasing of series number or seals;
- System design and installation are not in compliance with standards and regulations;
- The product has been improperly stored in end user's premises;
- Transport damage (including painting scratch caused by movement inside packaging during shipping). A claim should be made directly to shipping or insurance company.